

REVISIONS						
REV.	DESCRIPTION	REVISED BY	DATE	REQUESTED BY	APPROVED BY	DATE
1	Drawing released by Luciano on 05/15/13					
2	REVISED LAYOUT. ADDED SCHEMATIC	LL	7/10/2013	WT		
3	REVISED MODEL NUMBERS	LL	7/12/2013	VL		
4	REVISED AQUADUK MODEL NUMBER	LL	7/15/2013	WT		
5	REVISED PRODUCT LIST	LL	8/15/2013	WT		
6	REVISED SCHEMATIC	LL	8/26/2013	WT		
7	REVISED POSITION OF AQUAWAVE	LL	9/6/2013	WT		
8	REVISED FG SLIDE RUNOUT LENGTH	LL	9/10/2013	WT		
9	REVISED AQUADECK ENTRANCE	LL	9/11/2013	WT		
10	ADDED 360 SLIDE INSTALLATION DETAIL	LL	10/8/2013	WT		
11	REVISED SLIDE DETAIL ON DECK COORDINATES	LL	12/17/2013	PR		



EMPEX WATERTOYS
 591 Albright Rd.
 Uxbridge, ON
 Canada, L9P 1R4

Tel: 905 649 5047 Fax: 905 649 1757
 Toll Free: 1 866 833 8580

File Name: PR-WARNER ASSY

PARQUE REUNIDOS WARNER LAYOUT

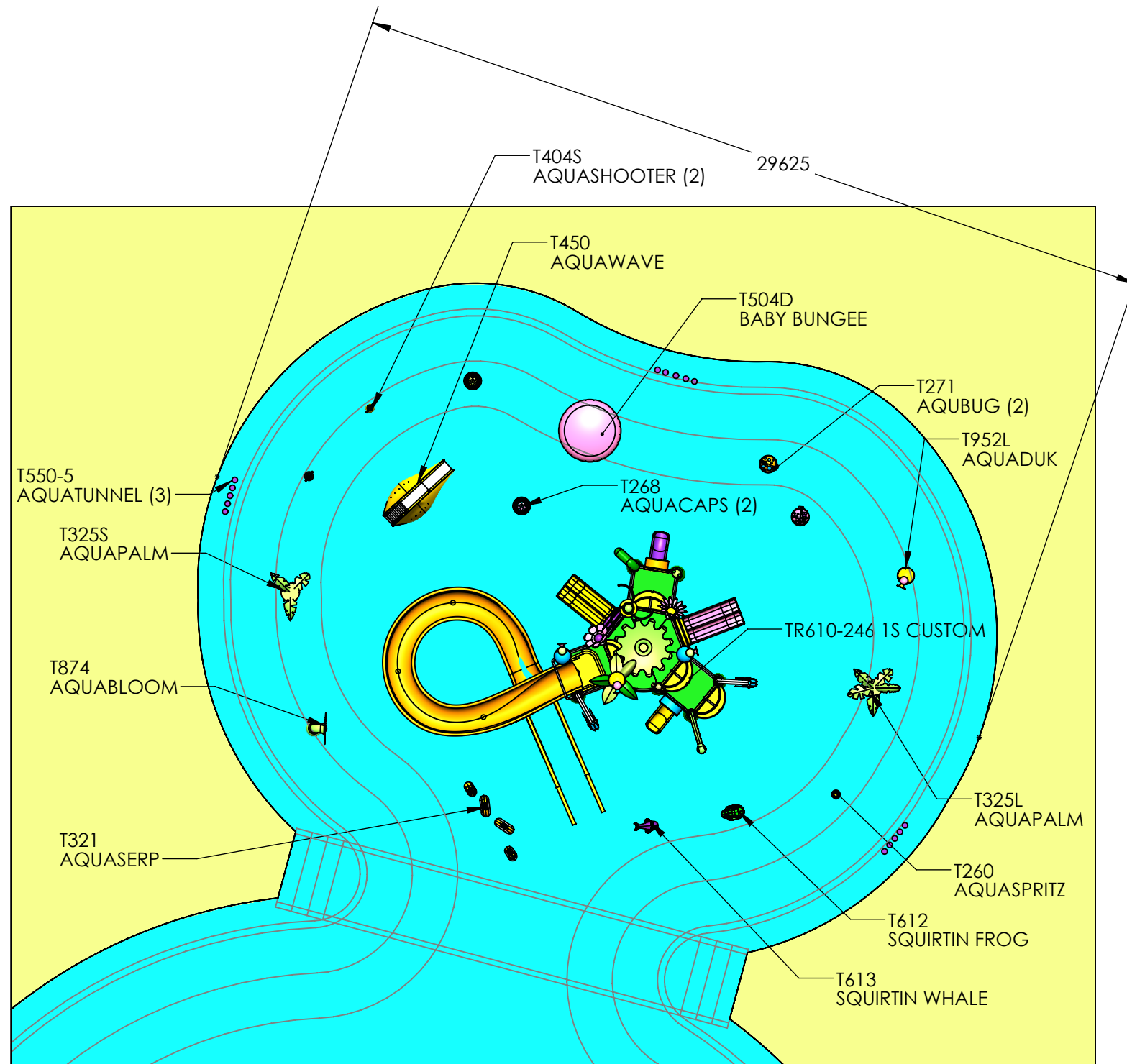

PROJECTION ANGLE

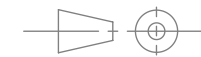

B

SIZE

SHEET SCALE:
1:200

UNITS
DUAL DIMS

Drawings are strictly Design Drawings and not intended to be used for toolmaking purposes. They are not considered final engineering drawings. Specifications for tolerances, tooling and manufacturing are the responsibility of the manufacturer unless otherwise specified.

All copyright, design and other intellectual property rights in the contents hereof are the sole and exclusive property of EMPEX WATERTOYS. The provision of this document to you does not afford you any ownership, rights or license to use or reproduce same, all of which remains the property of EMPEX WATERTOYS. Reproduction, storage in a retrieval system, or transmission in any form by any means, whether electronic, mechanical or otherwise, in whole or in part, without the prior written consent of EMPEX WATERTOYS, is strictly prohibited.

LAST REVISED ON

NAME Luciano

REV

DATE 12/17/2013

11

SHEET 1 of 5

8 7 6 5 4 3 2 1

D
C
B
A

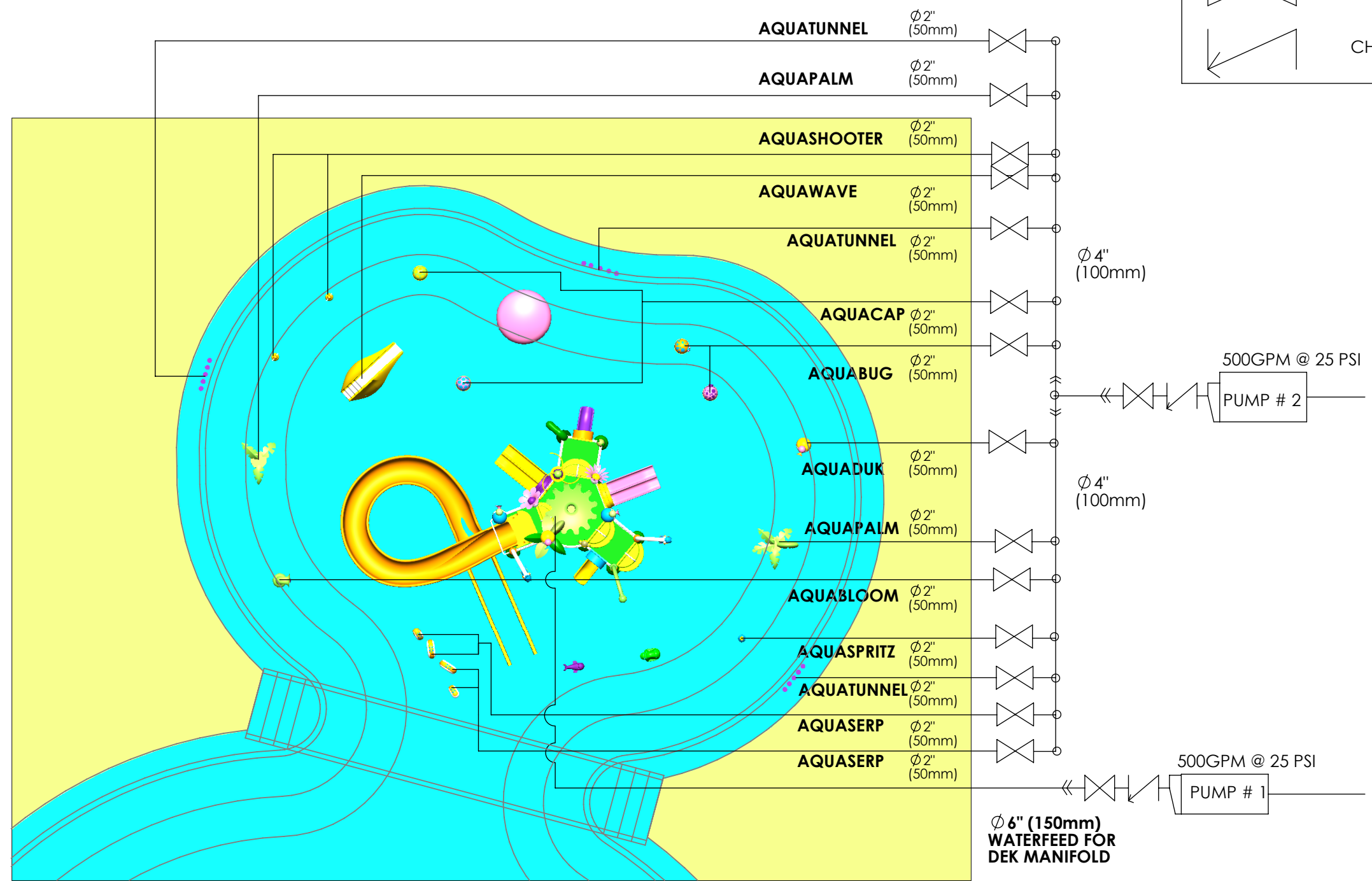

LEGEND

BALL VALVE

CHECK VALVE



EMPEX WATERTOYS
 591 Albright Rd.
 Uxbridge, ON
 Canada, L9P 1R4

Tel: 905 649 5047 Fax: 905 649 1757
 Toll Free: 1 866 833 8580

File Name: PR-WARNER ASSY

**PARQUE REUNIDOS
 WARNER LAYOUT**

SCHEMATIC

PROJECTION ANGLE

B
 SIZE

SHEET SCALE:
 1:200

UNITS
 DUAL DIMS

Drawings are strictly Design Drawings and not intended to be used for toolmaking purposes. They are not considered final engineering drawings. Specifications for tolerances, tooling and manufacturing are the responsibility of the manufacturer unless otherwise specified.

All copyright, design and other intellectual property rights in the contents hereof are the sole and exclusive property of EMPEX WATERTOYS. The provision of this document to you does not afford you any ownership, rights or license to use or reproduce same, all of which remains the property of EMPEX WATERTOYS. Reproduction, storage in a retrieval system, or transmission in any form by any means, whether electronic, mechanical or otherwise, in whole or in part, without the prior written consent of EMPEX WATERTOYS, is strictly prohibited.

LAST REVISED ON		REV 11
NAME	Luciano	
DATE	12/17/2013	

SHEET 2 of 5

- NOTE:
- 1) BUILDING MINIMUM 2.15m INTERNAL HEIGHT
 - 2) PUMP-1: GRISWOLD R4FH, 15HP, 500 USGPM@25 PSI, 6"x4"
 - 3) PUMP-2: GRISWOLD R4FH, 15UP, 500 USGPM @ 25 PSI, 6"x4"

8 7 6 5 4 3 2 1



EMPEX WATER TOYS
 591 Albright Rd.
 Uxbridge, ON
 Canada, L9P 1R4

Tel: 905 649 5047 Fax: 905 649 1757
 Toll Free: 1 866 833 8580

File Name: PR-WARNER ASSY

**PARQUE REUNIDOS
 WARNER LAYOUT**

DECK COORDINATES

PROJECTION ANGLE

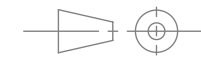

B

SIZE

SHEET SCALE:
 1:100

UNITS
 DUAL DIMS

Drawings are strictly Design Drawings and not intended to be used for toolmaking purposes. They are not considered final engineering drawings. Specifications for tolerances, tooling and manufacturing are the responsibility of the manufacturer unless otherwise specified.

All copyright, design and other intellectual property rights in the contents hereof are the sole and exclusive property of EMPEX WATER TOYS. The provision of this document to you does not afford you any ownership, rights or license to use or reproduce same, all of which remains the property of EMPEX WATER TOYS. Reproduction, storage in a retrieval system, or transmission in any form by any means, whether electronic, mechanical or otherwise, in whole or in part, without the prior written consent of EMPEX WATER TOYS, is strictly prohibited.

LAST REVISED ON

NAME Luciano

DATE 12/17/2013

**REV
 11**

SHEET 3 of 5

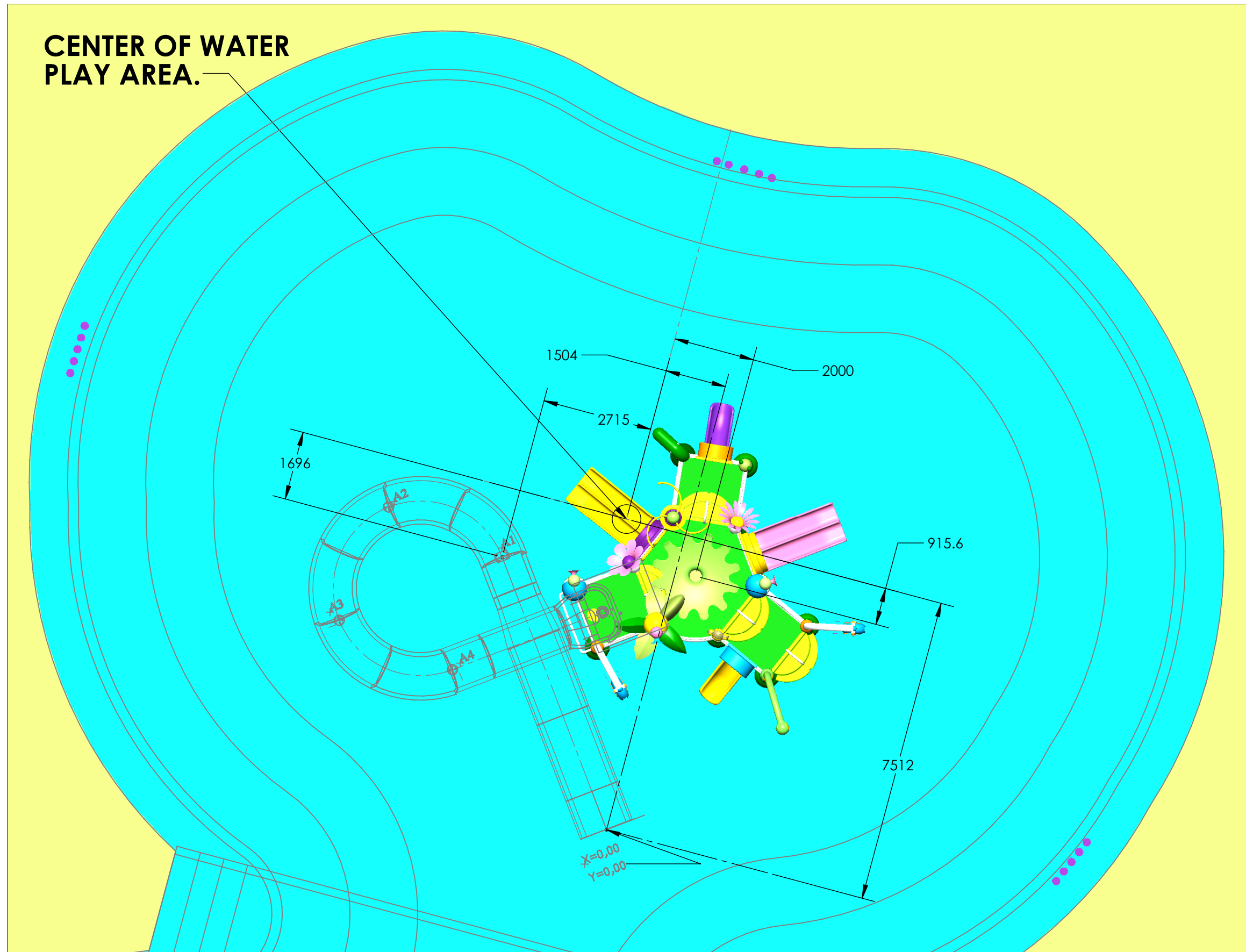



EMPEX WATERTOYS
 591 Albright Rd.
 Uxbridge, ON
 Canada, L9P 1R4

Tel: 905 649 5047 Fax: 905 649 1757
 Toll Free: 1 866 833 8580

File Name: PR-WARNER ASSY

**PARQUE REUNIDOS
 WARNER LAYOUT
 TOY COORDINATES**

PROJECTION ANGLE

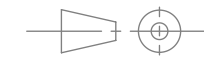

B

SIZE

SHEET SCALE:
 1:125

UNITS
 DUAL DIMS

Drawings are strictly Design Drawings and not intended to be used for toolmaking purposes. They are not considered final engineering drawings. Specifications for tolerances, tooling and manufacturing are the responsibility of the manufacturer unless otherwise specified.

All copyright, design and other intellectual property rights in the contents hereof are the sole and exclusive property of EMPEX WATERTOYS. The provision of this document to you does not afford you any ownership, rights or license to use or reproduce same, all of which remains the property of EMPEX WATERTOYS. Reproduction, storage in a retrieval system, or transmission in any form by any means, whether electronic, mechanical or otherwise, in whole or in part, without the prior written consent of EMPEX WATERTOYS, is strictly prohibited.

LAST REVISED ON

NAME

Luciano

DATE

12/17/2013

REV

11

SHEET 4 of 5

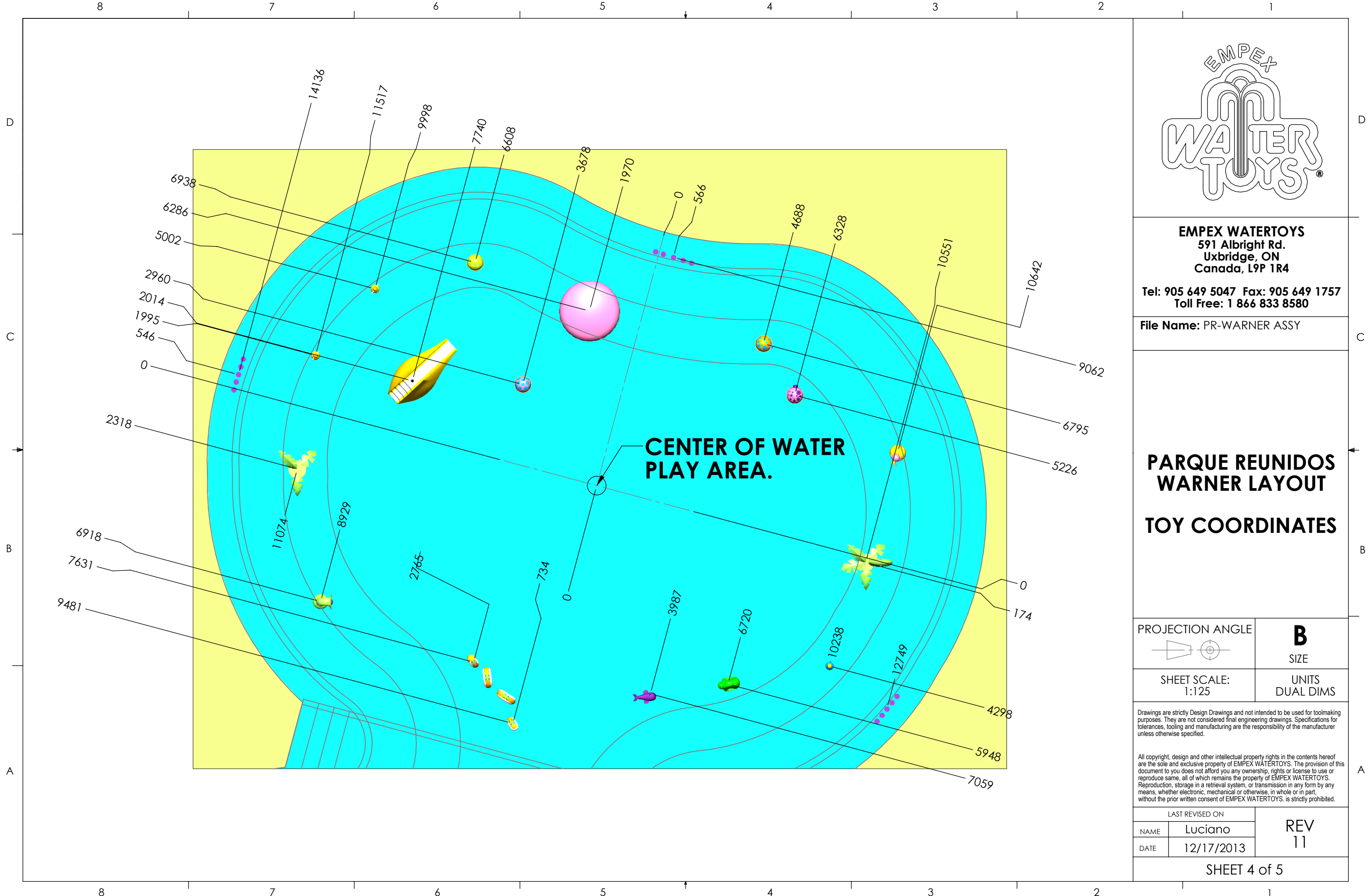

COLUMN NO	COORDINATE X(m)	COORDINATE Y(m)	BASE LEVEL (cm)	BASE PLATE DIMENSION(mm)	FOUNDATION DIMENSION(cm)	ANCHOR BOLT SET/DIAMETER
A1	0,00	7,19	0	320X220X10	90X90X60	4 M12
A2	-2,17	9,33	0	Ø250X10	110X110X60	4 M12
A3	-4,30	7,16	0	Ø250X10	120X120X60	4 M12
A4	-2,13	5,03	0	Ø250X10	130X130X60	4 M16



EMPEX WATERTOYS
 591 Albright Rd.
 Uxbridge, ON
 Canada, L9P 1R4

Tel: 905 649 5047 Fax: 905 649 1757
 Toll Free: 1 866 833 8580

File Name: 360 slide tech notes

CUSTOMER: EMPEX

**PARQUES REUNIDOS
 WARNER LAYOUT**

**360 SLIDE
 TECH DETAILS**

PROJECTION ANGLE

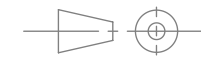

B

SIZE

SHEET SCALE:
 1:85

UNITS
 DUAL DIMS

Drawings are strictly Design Drawings and not intended to be used for toolmaking purposes. They are not considered final engineering drawings. Specifications for tolerances, tooling and manufacturing are the responsibility of the manufacturer unless otherwise specified.

All copyright, design and other intellectual property rights in the contents hereof are the sole and exclusive property of EMPEX WATERTOYS. The provision of this document to you does not afford you any ownership, rights or license to use or reproduce same, all of which remains the property of EMPEX WATERTOYS. Reproduction, storage in a retrieval system, or transmission in any form by any means, whether electronic, mechanical or otherwise, in whole or in part, without the prior written consent of EMPEX WATERTOYS, is strictly prohibited.

LAST REVISED ON

NAME Luciano

DATE 12/17/2013

REV
 11

SHEET 5 of 5

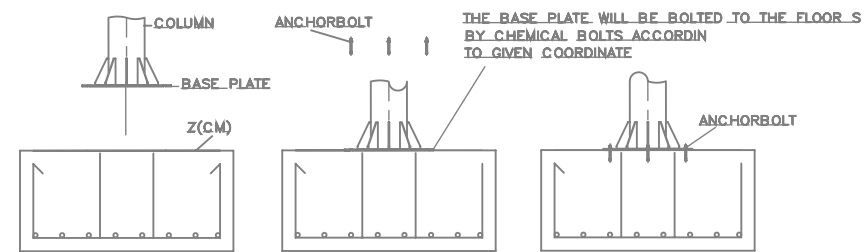
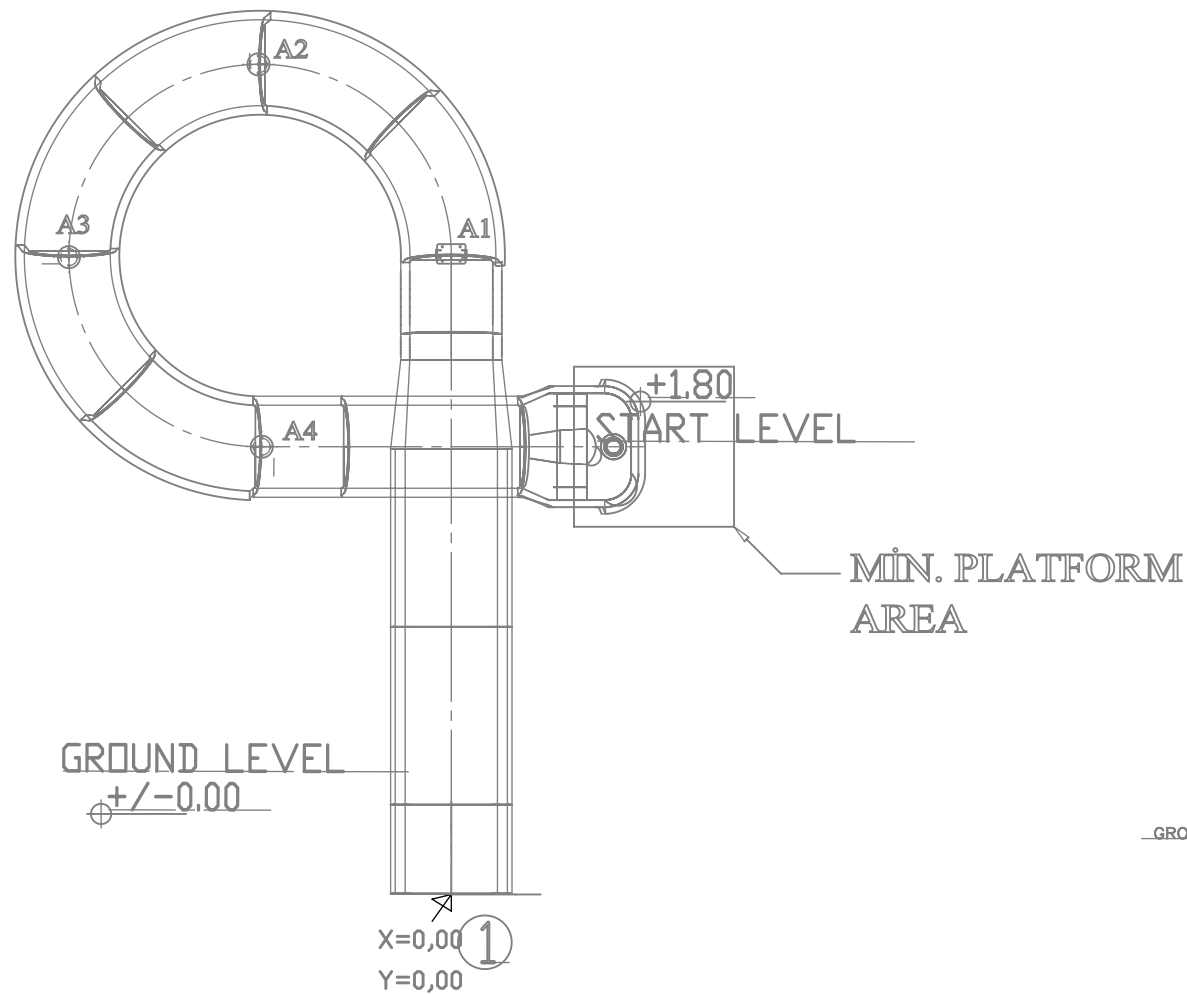

Column Installation Detail

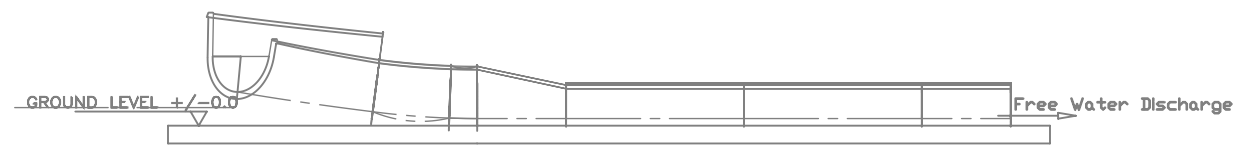

Waterslide Termination Detail.